

Warmup[®]

The world's **best-selling** floor heating brand™

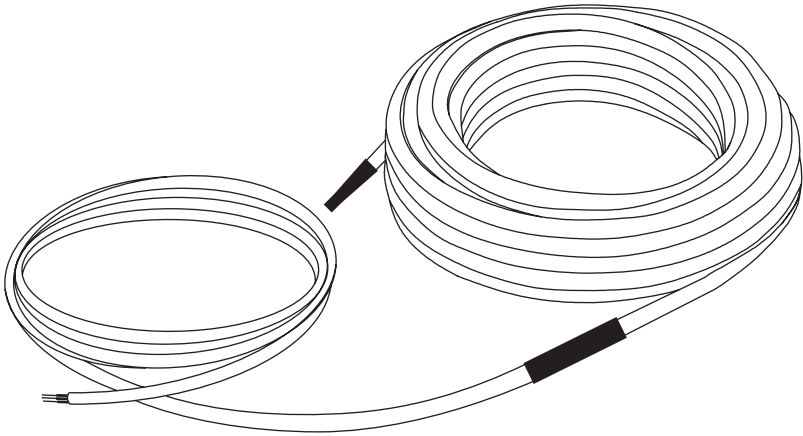

Installation Manual

Snowmelt Cable



Warmup Ireland
Web: www.warmup.ie
Email: ie@warmup.com
Telephone: 1 800 937 429

IMPORTANT

Read this manual before attempting to install your heating system. Incorrect installation could damage the heating system and will invalidate your warranty.



Contents

3	Important Installation points
4-5	Product Information
6	Important Information and Safety Tips
7	Controlling the system
8-12	Installation
13	Testing
14	Notes
16	Floor Plan
18	Control Card
19	Warranty

If these instructions are followed, you should have no problems during installation. However, if you require assistance at any point, please call our **Technical Helpline**

0845 345 2288

You can also find a copy of this manual, wiring instructions, a list of FAQs and other useful information at our website:

www.warmup.co.uk

Important Installation Points

1. The heating cables must be installed by a qualified electrician as per the current wiring regulations.
2. The heating cable should not be cut, shortened or lengthened.
3. The heating cable should not cross or overlap itself at any point. This could cause the cable to overheat.
4. Installation of the snow melting cable should not be undertaken if the ambient temperature is below -10°C.
5. Always take precautions not to damage the cable when laying it.
6. Do not space the cable closer than 80mm.
7. Take into account the location of construction and expansion joints. When planning for concrete finished surfaces, consider the location of the heating cable so as not to cross slab joints with the heating cable.
8. Take precautions to avoid damage to the heating cable during installation. Do NOT drop sharp objects or drive on the cable.
9. The minimum bending radius of the heating cable shall not be less than 6 times its diameter.
10. Snow/Moisture detection sensor location shall be in the open area, away from trees or bushes, so that it can sense moisture in the air/snowfall and initiate the energising of the heating cable.
11. Check the continuity and resistance of the snow cable before and after installation. The Resistance value should match the values shown on page 5. A tolerance of -5% to +10% is allowed.
12. The installation must be protected by a 30mA residual current device (RCD). Consult a qualified electrician.
13. Allow sufficient drying or curing period of the concrete/asphalt/mortar after installing the heating cable and before switching on the system.
14. The control card must be completed and fixed at distribution board indicating the location of the heating cables installed.
15. The joints (cold-warm transitions) must not be bent.
16. Ensure that all of the heating cable including the joints are completely embedded in the concrete.
17. Do not energise the heating cable while it is coiled up. This may result in damage to the cable due to overheating.

Safety Guidelines

Incorrect design, handling, installation, could damage the system and may result in inadequate frost protection or electric shock. To minimize these risks and to ensure that the system performs reliably, read and carefully follow the information, warnings, and instructions in this guide.

Ensure that the heaters are connected by a qualified electrician as per the current wiring regulations and are protected by a 30mA RCD at all times.

Product Information

Application

The Warmup Snow Melt Cable is the ideal solution for installation in concrete, asphalt or sand for melting ice and snow in outdoor areas such as driveways, pathways and steps. The cables in the range have a constant wattage output of 25 Watts/metre.

Covering Materials

Concrete /Asphalt and Pavers (in sand or concrete) may be used. The materials must be able to withstand temperature of 70°C.

Technical Specifications

Voltage	230Vac
Output	25 W/m
Cold Connection Cable	1 x 5m
Minimum Installation Temperature	5°C
Max Temperature of outer sheath	70°C
Minimum Bending Radius	6 x diameter of cable
Resistance tolerance	-5% / +10%
Outer Diameter	6mm for concrete, 7mm for asphalt
Cable colour	Orange for concrete, black for asphalt
Inner insulation	Fluoropolymer
Metal sheathing	Aluminium mylar tape with copper drain wire
Outer sheath	Polyolefin for concrete, High Temperature Polyolefin for asphalt; UV resistant

Range Specification

25 W/m for concrete application							
Model	Cable length (m)	Resistance (Ω)	Wattage (W)	Amps (A)	Area Covered		
					300W/sqm c-c 80mm	250W/sqm c-c 100mm	200W/sqm c-c 120mm
W25SM250	10	212	250	1.1	0.8	1.0	1.2
W25SM500	20	106	500	2.2	1.6	2.0	2.4
W25SM750	30	71	750	3.3	2.4	3.0	3.6
W25SM1000	40	53	1000	4.4	3.2	4.0	4.8
W25SM1250	50	42	1250	5.4	4.0	5.0	6.0
W25SM1750	70	30	1750	7.6	5.6	7.0	8.4
W25SM2250	90	24	2250	9.8	7.2	9.0	10.8
W25SM2750	110	19	2750	12.0	8.8	11.0	13.2
W25SM3300	132	16	3300	14.4	10.6	13.2	15.8
W25SM4250	170	12	4250	18.5	13.6	17.0	20.4
W25SM4750	190	11	4750	20.7	15.2	19.0	22.8

25 W/m for asphalt application							
Model	Cable length (m)	Resistance (Ω)	Wattage (W)	Amps (A)	300W/sqm c-c 80mm	Area Covered	
						250W/sqm c-c 100mm	200W/sqm c-c 120mm
W25SMAP3300	132	16	3300	14.4	10.6	13.2	15.8
W25SMAP4750	190	11	4750	20.7	15.2	19.0	22.8

Note: The minimum spacing for the Snowmelt heating cable is 80mm.

Important Installation and Safety Tips

All electrical work must be carried out by a qualified electrician per the current wiring regulations.

Before installing the heating cable, a suitable 230Vac electrical supply must be located. All wiring and controls must be capable of handling the load of the heating system - refer to the table on page 5 for amperage figures.

Conduits /Junction boxes

After choosing the location of the sensors, you will need to install a separate conduit in the floor for the sensor cables and cold leads back to the junction box/control panel. The sensor wires should ALWAYS be placed in their own, separate conduits. However you may place multiple heating cable COLD LEADS inside a single conduit. You should NEVER run any of the heating cable or the manufactured joint inside the conduit, as this will cause it to burn out.

Note: Always secure the conduit to the subfloor so that they do not move during the pouring of concrete.

The cold lead wires may be lengthened or shortened as necessary, but NEVER cut the heating cable.

When extending the lead wires, the use of a weatherproof junction box is required.

RCD

The heaters must be connected to the supply via a 30mA RCD as per the current wiring regulations.

Controlling the System

The Warmup snowmelt cable must only be controlled by approved Warmup control devices.

Temperature Controller for small installations (up to 16 Amps):

HCC-02 ETR2 -1550

Temperature Controller for large installations (up to 48 Amps):

HCC-01 ETO2- 4550

Carefully read the following sections when preparing for your sensor positioning.

Sensor types

Ground sensor type ETOG-55:

The sensor type ETOG is designed for embedding into the surface of the outdoor area. ETOG detects ground temperature and moisture, and should be installed in an open area away from trees or bushes, so that it can sense moisture in the air/snowfall and initiate the energising of the heating cable.

Note: Up to two sensors type ETOG can be installed.

Outdoor sensor type ETF-744/99:

The Outdoor sensor detects any rapid decrease in air temperatures, avoiding icy areas.

Note: The ETF sensor can also be used together with the ETOG sensor for outdoor areas.

The snow melting system will be energized only when the outdoor temperature is below the selected setting and snow or ice occurs on the ETOG.

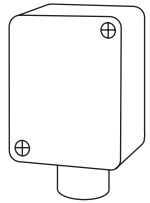
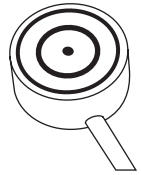

Placement of the sensors

When choosing the location of the sensor you will need to decide between fast detection (place it where the snow will appear first) or a lasting melting period (place it where the snow will melt last).

The ETOG Ground sensor(s) must be placed within the heated area between two of the wires runs.

Always maintain a minimum distance of 40mm between the sensor conduits and the actual heating cable. The conduit for wiring of the sensor is to be installed BEFORE concrete surface is cured and finished. The sensor itself is to be installed AFTER concrete surface is cured.

For measuring temperature alone the ETF sensor should be installed on a sound exterior structure such as an outside wall of a building.

Further information on the fitting of the sensor can be found in the thermostat instruction manual.

Testing

Testing the Cable

One of the most important steps to be taken when installing the mat is the testing process. You must ensure that the mat is tested BEFORE, DURING and AFTER installation.

Testing for Resistance

The resistance (ohms) of each mat should be measured across the conductors. The resistance readings should be within -5% and + 10% of the measurements in the tables on page 5.

Insulation resistance test

The heating cable should be tested between the conductors and earth at 500V and 1000V. All test results should be recorded on the control card at the end of this manual. If at any time the heating cable does not pass the insulation resistance test or your readings are not in line with tolerance of the values, or you suspect there is a problem, please call the Warmup Technical Helpline at 0845 345 2288.

Installation

Planning

Before you commence installation, ensure that you have carefully measured the area to be heated. Draw a plan detailing the spacing of the cable and location of the power connections.

Note: Ensure heating cable is at least 100mm from the edge of the pavement and from obstacles such as drains, pipes etc., and that the cable(s) selected meet your requirements.

Outdoor Temperature	Recommended output W/m ²
-5°C	200W/m ²
-10°C	200W/m ² - 250W/m ²
-15°C	250W/m ²
-20°C	300W/m ²

Note: This table should be used as a guideline only, your exact requirements may vary. Uninsulated areas may require a higher output.

To calculate the spacing that should be used for the project, measure the heated area and divide by the length of the wire to be used.

$$\text{Cable spacing (mm)} = \text{Heated area (sqm)} / \text{Total cable length (m)} \times 1000$$

Example: 20 sqm / 170 m x 1000 = 117mm

Fixing Methods

The Snowmelt may be fixed at set spacing intervals using the Warmup metal fixing bands (MFB).

If steel reinforcement mesh is already in place, the cable may be secured at set spacing intervals using plastic cable ties.

Do **NOT** use metal cable ties.

Note: The heating cable must not be installed closer than 80mm apart.

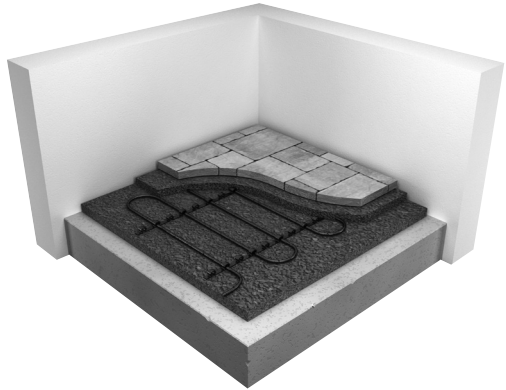

Flat areas

Start the installation at the point nearest to the junction box where the circuit will be terminated. Take the cold lead of the cable through conduit pipe.

Note: Take care when pulling the cold leads not to damage the cold lead connection joint.

Lay the cables according to the plan and fasten to the subfloor using your preferred method of fixing. Ensure that the cables are secured tightly so that they do not move during concrete pouring. Take care not to damage the heating cable or cross any expansion joints.

Note: The sensor cables and cold leads must be protected by a suitable conduit pipe.

Stairs:

The cable should be laid lengthwise on the steps so that they only lie on the horizontal surfaces. For this type of installation it is essential to have a concrete step as a base. The cables should be installed with the first run no more than 50mm from the edge of the step, the cable should then be laid at even spacing in the remaining space between the outer cable run and the back of the step.

Allow for the addition of railings etc that will require cutting or drilling into the concrete as damage could occur to the heating cable allow a clearance of 100mm between the heating cable and any planned cuts/holes.

Note: When running the cable up the riser of the step a groove should be made in the riser in order to keep the cable flat and avoid any damage. Always observe the minimum bending radius.

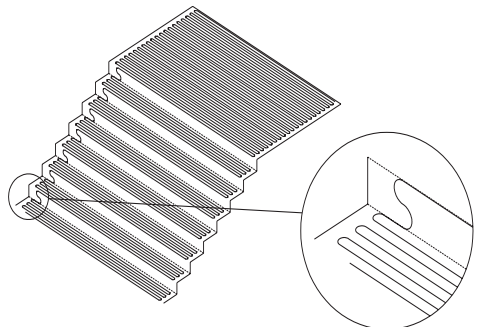

Installation Under Concrete

An electrician should measure the cable resistance and Insulation resistance before commencing installation, before pouring of concrete and after the concrete is poured. The readings should be recorded on the Control Card provided at the end of this manual. (See testing guide on page 8)

Note: The conduit for wiring of the sensor and supply cables must be installed BEFORE concrete surface is cured and finished.

1. Clean the area below the heating cable so that it is free from any sharp objects.
2. Take the cold lead of the cable through conduit pipes into the junction box. Seal the ends of the conduit so that concrete does not seep in.

Note: Do not use excess forces to pull the cold leads otherwise it may damage the cold lead joint.

3. Lay the cables according to the plan and secure using your preferred method of fixing. (See page 9)
4. Pour the concrete onto the area covering the cables completely without leaving any air pockets. Ensure that all of the heating cable including the manufactured joints are completely embedded within the concrete.

Note : The concrete mixture must not contain sharp stones as these may damage the cables.

5. The concrete should have a minimum thickness of 50 mm measured from the top of the snow melting cable.
6. Once the concrete has cured, position the sensor within the heated area in a location where it can sense the moisture in the air / snow fall, away from trees and bushes.

Further information on the fitting of the sensor can be found in the thermostat instruction manual.

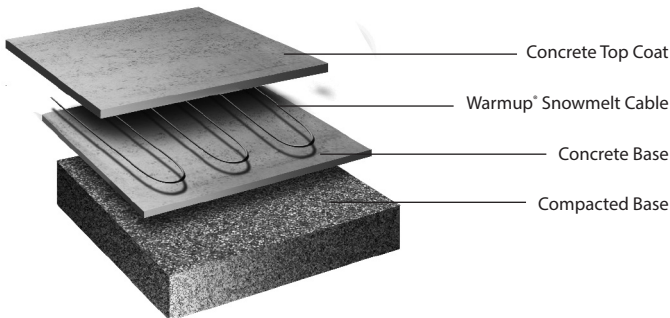

Installation Under Pavers

An electrician should measure the cable resistance and Insulation resistance before commencing installation, before, during and after installation of the pavers. (See testing guide on page 8)

The readings should be recorded on the Control Card provided at the end of this manual.

Note: The conduit for wiring of the sensor and supply cables must be installed BEFORE concrete surface is cured and finished.

1. Clean the area below the heating cable so that it is free from any sharp objects.
2. Take the cold lead of the cable through conduit pipes into the junction box.

Note: Do not use excess forces to pull the cold leads otherwise it may damage the cold lead joint.

3. Lay the cables according to the plan and secure using your preferred method of fixing. (see page 9)
4. Apply a minimum bed of 30mm of sand over the heating cable to ensure easy positioning of the pavers.
5. Take care when spreading the sand not to use sharp tools that may damage the cable.

Note: All of the heating element including the manufactured joints must be embedded within sand.

6. Position the snow sensor within the heated area in a location where it can sense the moisture in the air / snow fall, away from trees and bushes.

Further information on the fitting of the sensor can be found in the thermostat instruction manual.

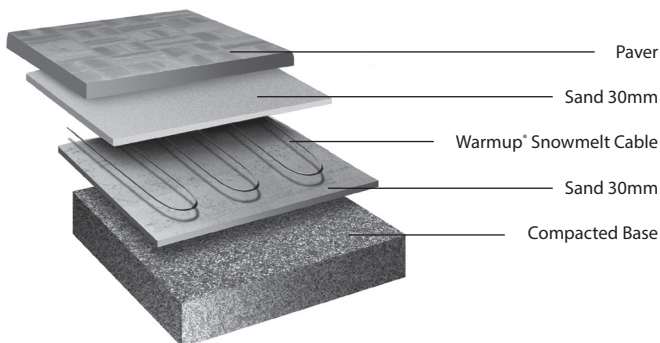

Installation Under Asphalt - Models W25SMAP only

Important Information regarding Asphalt

The cable can be covered directly with asphalt as it can resist up to 240 °C for a short time. It is not necessary to cover the cable with sand or concrete prior to the asphalt. Rollers or asphalt laying machines should NOT be used on the cables.

1. Clean the area below the heating cable so that it is free from sharp objects.
2. Take the cold lead of the cable through conduit pipes into the junction box. Seal the ends of the conduit so that the asphalt does not seep in.

Note: Do not use excess forces to pull the cold leads otherwise it may damage the cold lead joint.

3. Lay the cables according to the plan and secure using your preferred method of fixing (see page 9).
4. The concrete top coat must be a minimum thickness of 50 mm measured from the top of the snow melting cable and should cover the cables completely without leaving any air pockets. Ensure that all of the heating cable including the manufactured joints are completely embedded within the concrete.
5. Pour the asphalt onto the area.
6. After the Asphalt has hardened position the sensor within the heated area in a location where it can sense the moisture in the air / snow fall.

Further information on the fitting of the sensor can be found in the thermostat instruction manual.

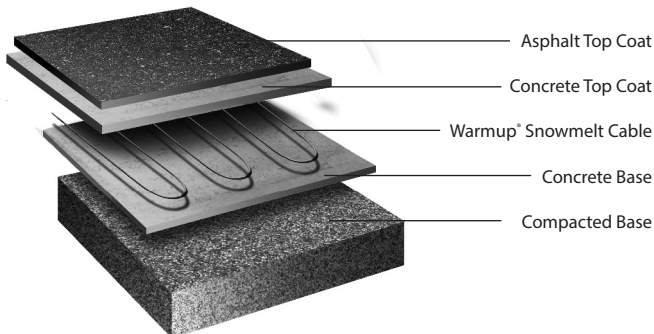

Installation - Roof and Gutter

Items for installation (dependent on installation type)

1. WSC - Downspout hanger reel

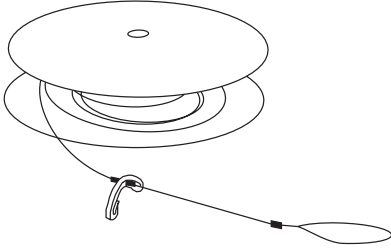

2. WGB - Gutter bar set

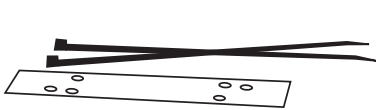

3. Warmup roof clips

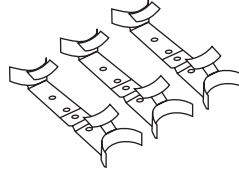

4. Aluminium adhesive tape

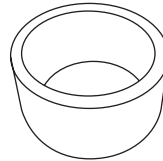

Other Items Needed:

Temperature Controllers:

ETR2 -1550

HCC-02

ETO2- 4550

HCC-01

Sensors:

ETOR-55

ETF 744/99

Important Installation and Safety Tips

The installation must be carried out by a qualified electrician.

The cable must be connected to a suitable socket or junction box and must always be protected by a 30mA RCD per the current wiring regulations.

If the RCD trips during normal operation, and cannot be reset, there is likely a fault in the circuit. No attempt should be made to re-energise the cable, and the RCD must not be bypassed in any circumstances. Consult a qualified electrician.

Sensor Locations

Sensor type ETOR-55 is designed for mounting in gutters.

The sensor must be placed in the gutter on the sunny side of the building. The contact elements of the sensor must be placed in the direction of the flow of the melting water. Where necessary, it is possible to connect two sensors in parallel.

Sensor Type ETF 744/99 detects temperature and must be used in combination with the ETOR-55 sensor, in order to control the roof heater efficiently.

The ETF sensor should be installed on a sound exterior structure such as an outside wall of a building.

Note: The snow melting system will be energized only when the outdoor temperature is below the selected setting and moisture occurs on the ETOR.

Further information on the fitting of the sensor can be found in the thermostat instruction manual.

Planning

Before fitting the heating cable make sure that the area around the cable is freely accessible and that there are no sharp edges. Inspect the heating cable before using it for any sign of damage.

Allow the cable to warm up to room temperature before installing. Ensure gutter is clear removing any leaves or debris from the gutters and downspouts.

Installation of the self-regulating cable on shingled roof should only be done between 0 and 27°C. Below 0 °C shingles are brittle and may break off when lifted to install roof clips. Above 27°C shingles may be warm and may tear when lifted to install roof clips.

For each roof area that has cable, the corresponding gutter must also have cable.

When using a junction box, it should be mounted in a sheltered area.

Start the installation at the junction box, leaving a drip loop where the cable exits the junction box.

If working directly on the roof during installation, it is advised to mark the cable with chalk beforehand. A project drawing will help with planning the length of cable per roof feature.

Before you commence installation ensure that you have carefully measured the area to be heated. The heater must be arranged so that it routes melted water from warm areas (where ice on the roof usually melts first) to cold areas.

The heating cable is specifically intended for problem areas and does not need to be installed on all areas of the roof – install only in the sections that have been susceptible to ice dams in the past.

If a gutter is present this must also be heated to allow for the drainage of melted snow/ice.

Draw a plan detailing the spacing of the cable and location of the power connections.

Ensure that the cable(s) selected meet your requirements.

Outdoor Temperature	Recommended output W/m ²
-5°C	200W/m ²
-10°C	200W/m ² - 250W/m ²
-15°C	250W/m ²
-20°C	300W/m ²

Note: This table should be used as a guideline only, your exact requirements may vary. Uninsulated areas may require a higher output.

Installation Patterns

Methods for arranging the cable pattern for different parts of the roof can be found on the following pages.

Always install cable in valleys that are a part of any problem area on your roof. You may or may not need to install cable along the roof line or near skylights or dormers.

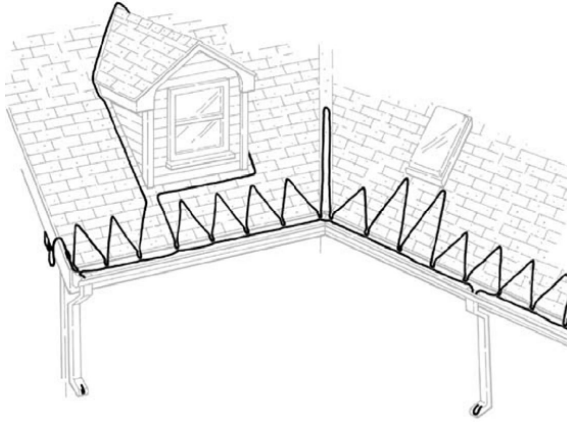

Roof Line Pattern

For installation in eaves the cable should be laid along the roof line in a triangular pattern. The cable must extend above the overhang into the warm section of the roof. The height of each triangle will be dependant on the size of the roof overhang.

To measure the depth of the overhang and to determine the height of the triangle use the tables on pages 23 & 24.

Note: The Triangle heights are measured by the number of shingle rows from the edge of the roof (based on a standard shingle size -14cm) This method allows for the heating cable to extend at least one shingle row into the roof area.

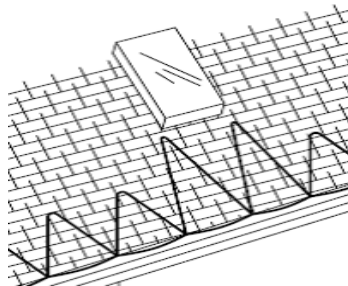

Installation Patterns; continued

Skyline Pattern

Problem skylight areas should use the “triangle pattern” approach. However, the height of the triangles may need to be greater than those along the roof line.

Increase the triangle height so that it extends to the base of the skylight.

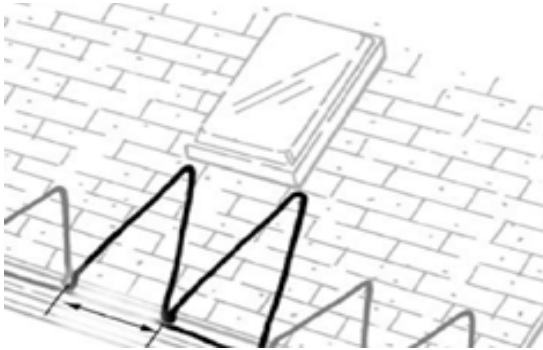

Dormer Pattern

To treat a problem dormer area, the cable should run up and around the dormer.



Installation Patterns; continued

Valley Pattern

If a valley exists in a problem area of your roof, you must route cable up and back down the valley a minimum of 1 meter.

Extend the cable higher if the warm area of your roof is higher.

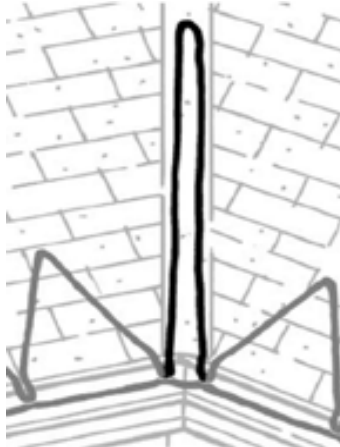

Gutter and Down Pipes

If a gutter is present, all gutters below the heated areas of the roof must also be heated to allow for the drainage of melted snow/ice.

If a downspout is present along the route of the gutter, the cable should run down the downspout and back up in a loop and continue along the gutter.

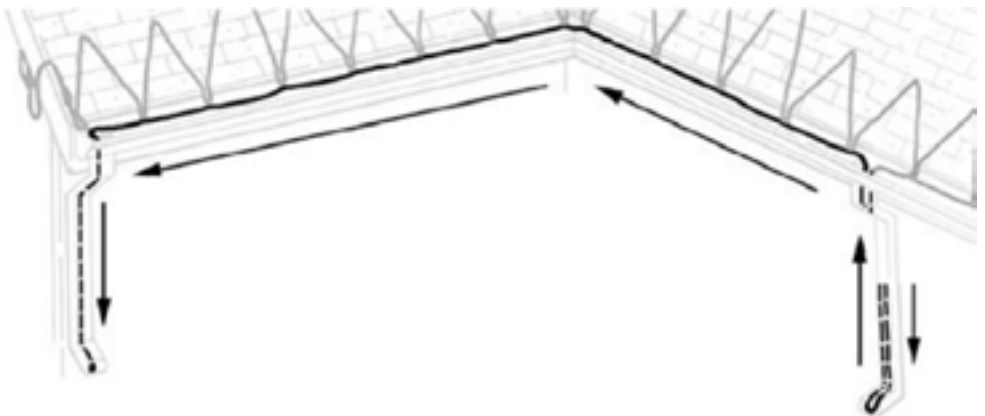

Application: in Gutter

The simplest installation occurs when the project requires only de-icing of a gutter.

1. To attach the cable properly it must lie flat in the gutter. The cable should be uncoiled ensuring it is not twisted or tangled.
2. The cable should be held tightly, whilst not touching the gutter itself to prevent heat loss.
3. If treating gutters for ice build up, use a double run of cable.
4. Once the length of cable required is determined, the terminated cable end should be attached to the gutter using an appropriate method, ie aluminium adhesive tape. Permanent methods such as glue or adhesive should not be used.
5. For this installation the gutter bars are used. UV resistant cable ties are pushed through the holes on the bar and fasten loosely so that the cable is held, but not secured.
6. Repeat step 5 with as many bars as required for the gutter length, using 1 clip every 20cm of gutter.
7. For round gutters the bar will need to be bent around the edge of the gutter, and the inside profile. Pliers can be used for this (see Figure 3).
8. Once all bars are attached along the cable, begin adhering them to the inside surface of the gutter. Check the spacing and use the aluminium adhesive tape to hold the bars down.
9. All cable ties should be tightened and trimmed as in Figure 3.

NOTE: The parallel runs of cable should be kept separate, and evenly spaced throughout.



Figure 1. Gutter bar & cable ties

Application : in Gutter; continued

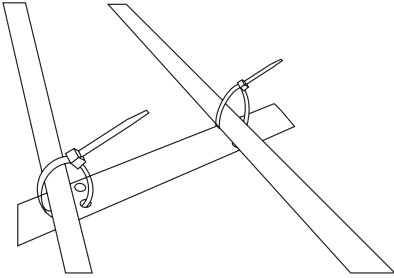

Figure 2. Gutter bar & cable ties

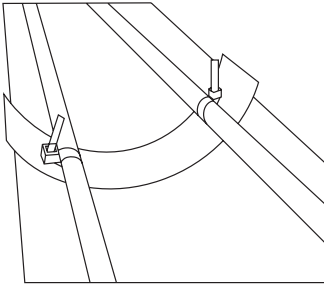

Figure 3. Bar attached to gutter

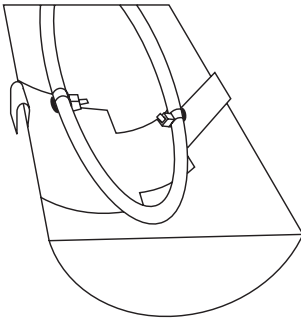

Figure 4. Bar adhered to gutter with aluminium tape

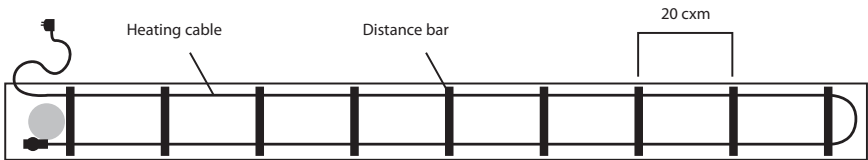

Figure 5. Final installation in a gutter

There are 2 types of downspout installations:

- those where the downspout is in the middle of a gutter length and
- those where the downspout is at the end of the gutter run

Where the downspout is in the middle of a gutter run, the cable will need to route down and back up, to continue along the gutter. The cable should not extend beyond the end of the downspout. Take this into account when calculating cable length for the project.

Remember to avoid overheating the cable, as this increases the risk of fire or electric shock. No part of the downspout should be inside a building.

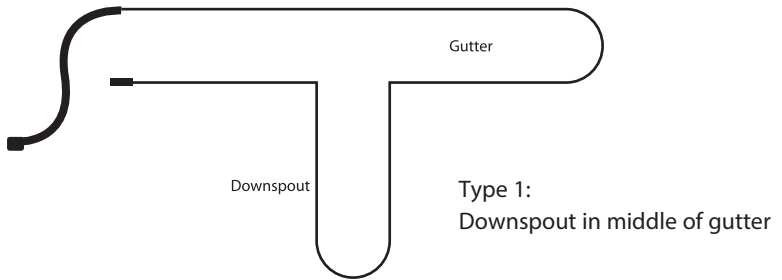

1. For downspout installations running along the gutter, the cable should be routed down the pipe and back up.
2. Once the length of cable required is determined, the terminated cable end should be attached to the gutter before the downspout using an appropriate method, i.e. aluminium adhesive tape. Permanent methods such as glue or adhesive should not be used.

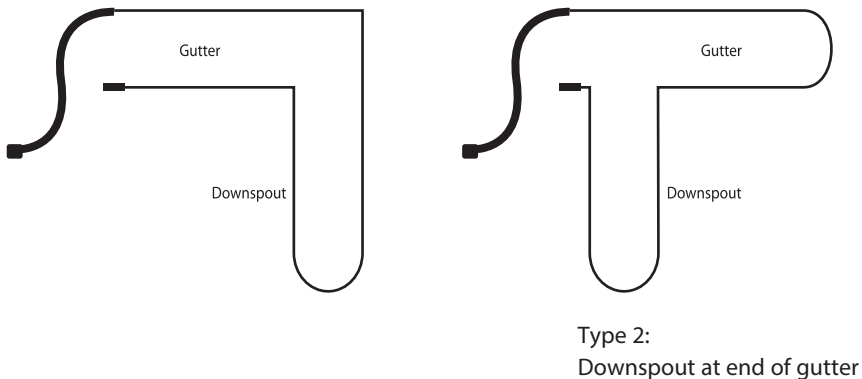

3. The length of steel wire needed should be measured from the looped end of the downspout hanger reel. This includes the length of gutter leading to the downspout, and for the downspout itself. The cable should be flush with the end of the spout.
4. The cable is then attached to the downspout hanger using the clips (see Figure 3). The clips are spaced at 40mm intervals.
5. On the end of the hanger reel is a looped end for holding the run in place and keeping the steel wire tensed. Attach this loop to a secure object which will not break or fall off with the weight of the cable being supported in the downspout.
6. Where the downspout is at the end of the gutter to be heated, parallel runs of the cable will be supported via the steel wire, and return via the same gutter. Where the gutter continues after the downspout, the cable will only have parallel double runs in the downspout itself, and will continue along the gutter as required.

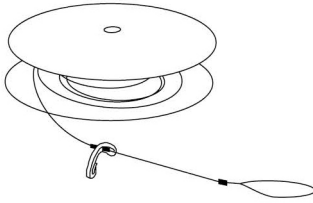

Figure 1. Downspout hanger

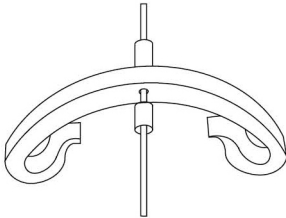

Figure 2. Downspout hanger clip

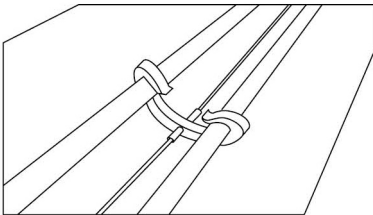

Figure 3. Downspout hanger clip holding cable

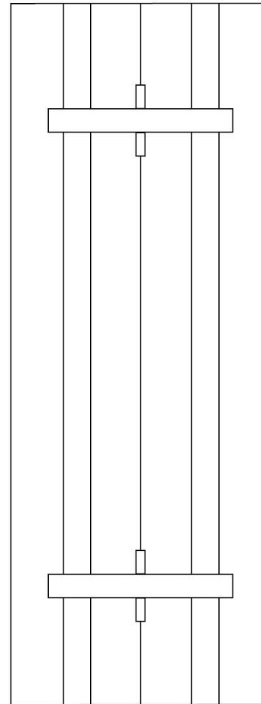

Figure 4. Cable held in parallel in the downspout

- Once all parts of the cable are clipped in, the cable with the steel wire can be dropped into the downspout, ensuring the steel wire is in tension to keep the cable in paralleled equal spacing.

Estimating the amount of cable

Estimating the amount of cable needed

Area	What to measure	How to calculate
Along roof	Overhang Length of Roof	Length of roof x overhang multiplier
Dormer	Distance around the dormer	Number of dormers x distance around the dormers
Valley	Number of valleys	Number of valleys x 1.8 meters
Gutter	Length of gutter	Length of gutter
Downspouts	Number of downspouts Length of downspouts	Number of Downspouts x Length of downspout x 2

Table for overhang multiplier

Roof Overhang	Multiplier for Roof with Gutters	Multiplier for Roof without Gutter
Less than 30cm	4.0	3.0
30	4.0	3.0
60	5.3	4.3
90	6.8	5.8
120	8.1	7.1
150	9.6	8.6
180	11.2	10.2
Downspouts	Number of downspouts Length of downspouts	Number of Downspouts x Length of downspout x 2

Note: For overhangs that are not listed estimate multiplier. E.g. For an overhang of 45cm with a gutter, multiplier will be approx 4.7.

Triangle Heights

Overhang (cm)	Triangle height (H) (Standard Shingle row- 14cm)
Less than 30cm	3
30-46cm	4
46cm- 60cm	5
60- 76cm	6
76cm-91cm	7
91cm – 106cm	8
106cm- 120cm	9
120cm – 137cm	10
137cm – 152cm	11
152cm – 167cm	12
167cm – 183cm	13

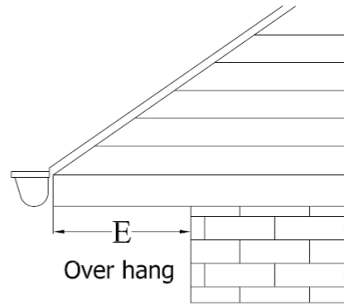

Plan

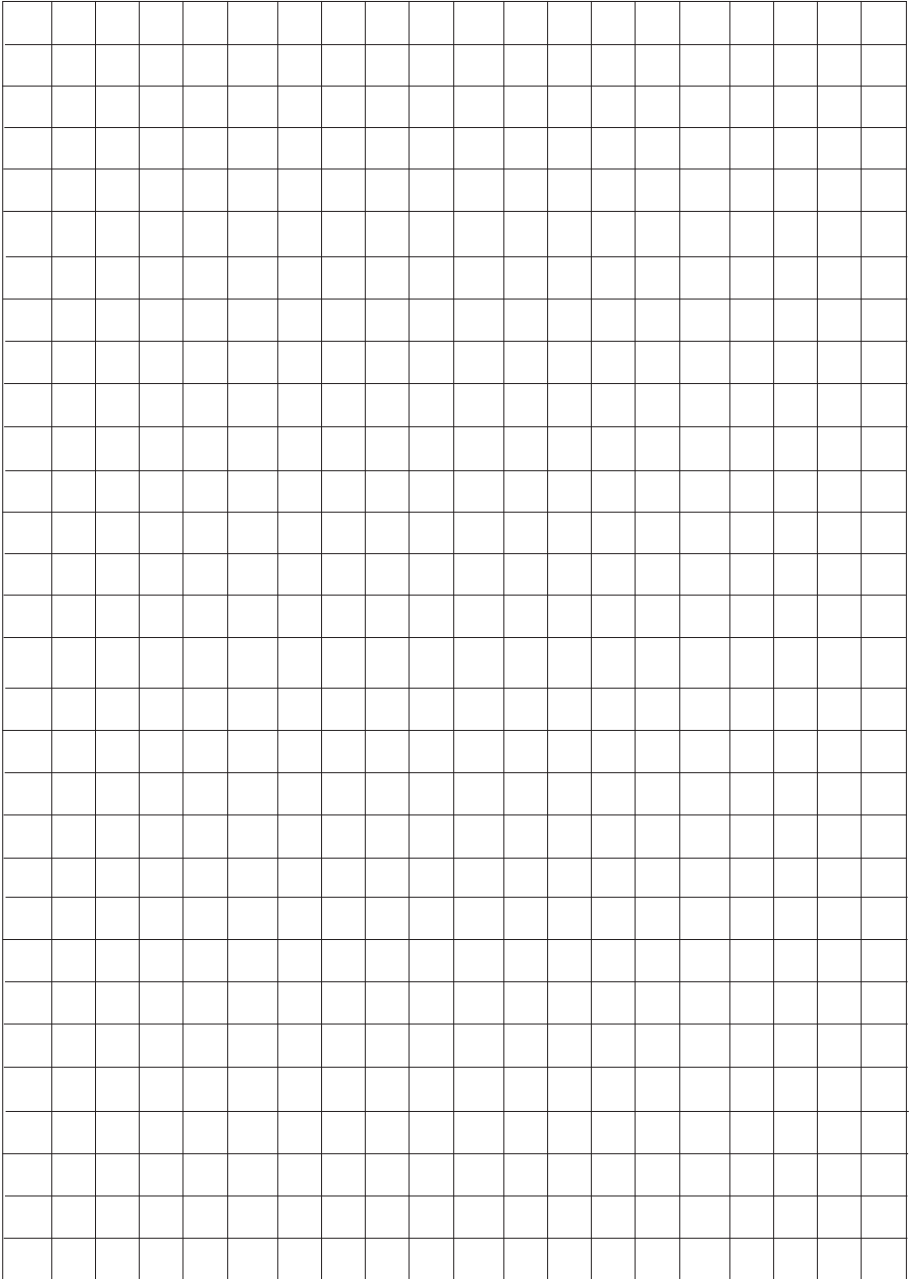

Control Card

Place this card in a visible spot close to the consumer unit.

Warmup
The best underfloor heating - **guaranteed**

Heater Location _____

Total Wattage _____

Caution!

Risk of electric shock Snowmelt heating cable installed below floor. Do not penetrate floor with sharp devices that may damage the heating cable.

Attention:

- Do not cut or shorten the heating element.
- Ensure that all of the heating wire including the joints completely embedded in the concrete/sand.
- Ensure that the heaters are used in conjunction with a 30mA RCD at all times.

Heater Model	Resistance Before	Resistance After	Insulation Resistance

_____ Date

_____ Signed

_____ Company stamp/name

This form must be completed as part of the Warmup Guarantee. Ensure that the values are as per the instruction manual.

This card must be situated close to the consumer unit in a visible place.

Note: Draw a Plan showing the layout of the heater.

Warmup Plc 702 & 704 Tudor Estate Abbey Road London NW10 7UW T: 0845 345 2288 F: 0845 345 2299 www.warmup.co.uk

Warranty



Warmup® Frost Protection Cable is guaranteed for a period of 10 years by WARMUP PLC ("Warmup") to be free from defects in materials and workmanship under normal use and maintenance, and is guaranteed to remain so subject to the limitations and conditions described below:

The 10 year Guarantee applies:

1. Only if the unit is registered with Warmup® within 30 days after purchase. Registration can be completed online at www.warmup.co.uk. In the event of a claim, proof of purchase is required, so keep your invoice or receipt – such invoice should state the exact model that has been purchased.
2. Only if the heater has been earthed and protected by a 30mA Residual Current Device (RCD) at all times.
3. Only if the heaters have been tested and electrical work and connections have been undertaken by a qualified electrician in accordance with IEE regulations and in accordance with these installation instructions.

During the period of guarantee, the manufacturer will arrange for the heater to be repaired or (at its discretion) have parts replaced.

If the heater fails due to damage caused during installation, this guarantee does not apply.

THE MANUFACTURER SHALL IN NO EVENT BE LIABLE FOR INCIDENTAL OR CONSEQUENTIAL DAMAGES, INCLUDING BUT NOT LIMITED TO EXTRA UTILITY EXPENSES OR DAMAGES TO PROPERTY.

WARMUP® PLC is not responsible for:

1. Damage or repairs required as a consequence of faulty installation or application.
2. Damage as a result of floods, fires, winds, lightning, accidents, corrosive atmosphere or other conditions beyond the control of the manufacturer.
3. Use of components or accessories not compatible with the units.
4. Normal maintenance as described in the installation and operating manual.
5. Parts not supplied or designed by the manufacturer.
6. Damage or repairs required as a result of any improper use, maintenance, operation or servicing.
7. Failure to start due to interruption and/or inadequate electrical service.
8. Any damage caused by frozen or broken water pipes in the event of equipment failure.
9. Changes in the appearance of the product that does not affect its performance.

Warmup[®]

The world's **best-selling** floor heating brand™

Warmup Ireland

Web: www.warmup.ie

Email: ie@warmup.com

Telephone: 1 800 937 429

Warmup PLC

702 & 704 Tudor Estate
Abbey Road
London
NW10 7UW

W: www.warmup.co.uk

E: uk@warmup.com

T: 0845 345 2288

F: 0845 345 2299